

**NEW RANGE  
NOW IN STOCK**



**ParkerTools**

# POSIglaze

**FRAMELESS GLASS BALUSTRADES**

[sales@parkertools.co.uk](mailto:sales@parkertools.co.uk) 01227 783222 [www.parkertools.co.uk](http://www.parkertools.co.uk)



**Next Day  
Delivery**



**Instant Pricing  
Buy Online**



**FREE Quotes  
From Drawings**

“POSIglaze is the  
**MOST FORGIVING**  
balustrade system that  
I’ve used”

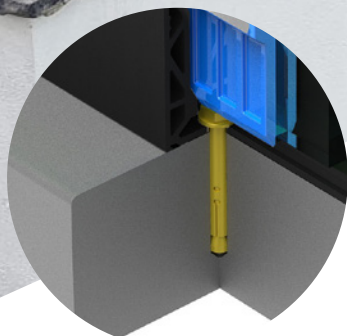
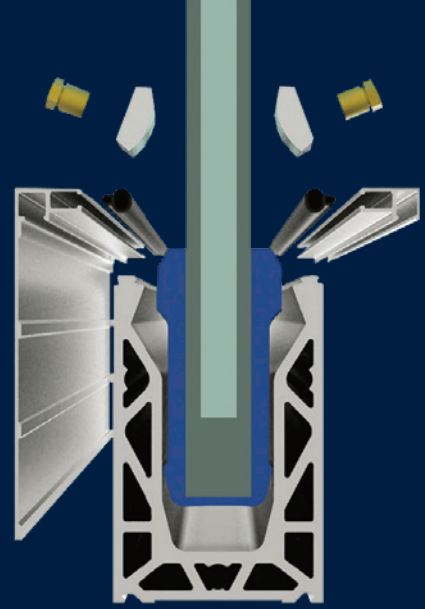

## BASE MOUNT

The most popular fixing choice is a base-mounted channel, fixed to your concrete or steel substrate through drill holes in the base of the channel. Available in both black brushed and silver brushed finishes.

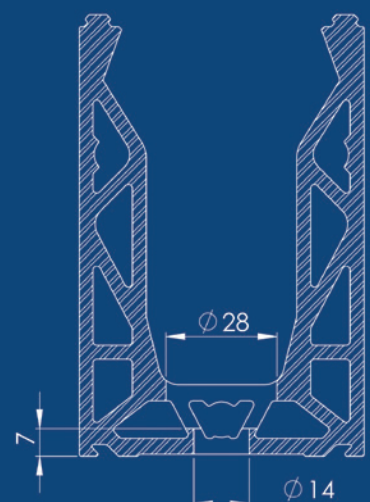

SECTION D-D  
Base Mount

# "POSIglaze is **EXTREMELY VERSATILE** and installer-friendly"



**Fast & Easy to Install & Adjust**



**Appropriate for Domestic & Commercial**



**Accredited to 1.50kN to BS 6180:2011**



**Can be used with a wide range of glass types**



**Lightweight & Strong**



**Suitable for use on uneven surfaces**

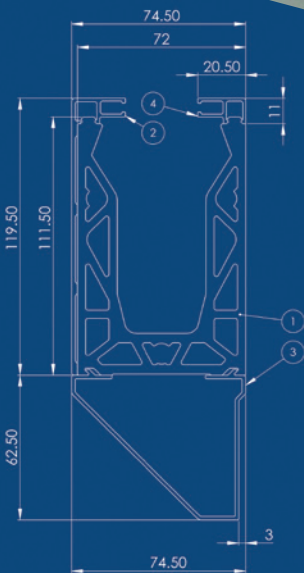

Side Mount

## **SIDE MOUNT**

For when your balustrade needs to be side fixed, the side-mounted channel has drill holes in the side. Available in a natural anodised finish with silver brushed cladding.

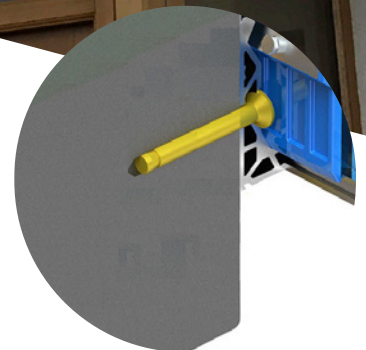

# TECHNICAL SPECIFICATION



The table below shows the line loading that POSglaze is certified to achieve.

These tests have been conducted in accordance with BS6180:2011 to certify that POSglaze meets the force loading requirement under this British standard for a range of glass height and thickness configurations.





	Glass Type >	12mm Toughened Glass		15mm Toughened Glass		19mm Toughened Glass		21.5mm SentryGlas		
		1100	1200	1100	1200	1100	1200	1100	1200	
0.36kN Line Load	Base Mounted	Concrete	200mm Bolt Holes	✓		✓				✓
		Concrete	400mm Bolt Holes	✓		✓				
		Steel	200mm Bolt Holes	✓	✓	✓				✓
	Side Mounted	Concrete	200mm Bolt Holes	✓		✓				✓
		Concrete	400mm Bolt Holes	✓		✓				
		Steel	200mm Bolt Holes	✓	✓	✓				✓
0.74kN Line Load	Base Mounted	Concrete	200mm Bolt Holes						✓	
		Concrete	400mm Bolt Holes							
		Steel	200mm Bolt Holes						✓	
	Side Mounted	Concrete	200mm Bolt Holes			✓			✓	
		Concrete	400mm Bolt Holes			✓				
		Steel	200mm Bolt Holes			✓		✓	✓	
1.50kN Line Load	Base Mounted	Concrete	200mm Bolt Holes				✓		✓	
		Concrete	400mm Bolt Holes							
		Steel	200mm Bolt Holes				✓		✓	
	Side Mounted	Concrete	200mm Bolt Holes						✓	
		Concrete	400mm Bolt Holes							
		Steel	200mm Bolt Holes						✓	

## BASE FIX CHANNEL

ITEM	Stock No.	Price
 3mtr Length	200-90-82	£165
 Top Seal 2x required for every 3m	200-90-90	£9
<b>Channel, 2x Top Seal &amp; Glass Kit</b>		<b>£75/m</b>

## SIDE FIX CHANNEL

ITEM	Stock No.	Price
 3mtr Length	200-97-02	£165
 3mtr Cladding 1x required for every 3m	200-97-10	£28
 Top Seal 1x required for every 3m	200-97-28	£9
<b>Channel, Cladding, Top Seal &amp; Glass Kit</b>		<b>£81/m</b>

GLASS KIT	Stock No.	Price
 Glass Kit	12mm 201-03-20 15mm 201-03-38 19mm 201-03-53 21.5mm 200-91-08	£42

ACCESSORIES	Stock No.	Price
 Corner - 90 Degree	200-97-44	£62
 Dowels - Pack of 2	200-97-51	£1/ea
 End Cap - Slot In	200-97-69	£7/ea
10mm Spanner	200-97-77	£3.50

Terms & Conditions. Prices are correct at time of printing. All prices exclude VAT. Prices may be subject to change. Free Carriage is based on values excluding VAT. For orders made over the phone a £12.50 carriage charge will be added on all orders below £100, orders above this will be carriage free. For orders made online a £4.99 carriage charge will be added on all orders below £75, orders above this will be carriage free. 2021 ParkerSteel Ltd. E & OE

Call or Email today for a  
**FREE Quote:**

• 01227 783 222

• sales@parkertools.co.uk